



Model 80 a 100



Model 120



Model 80 a 100

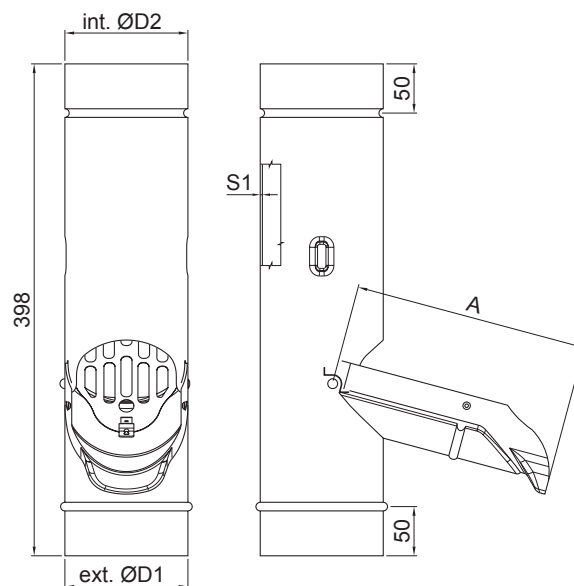



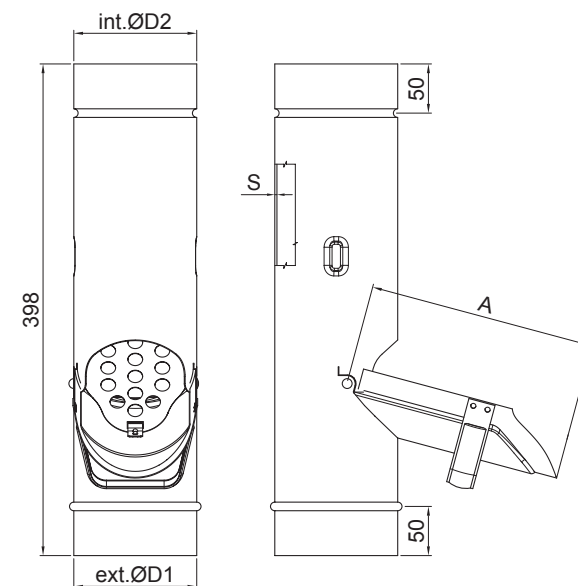







Model 120



Menovité rozmery (mm)	80	100	120
S1	0,70	0,70	0,70
A	150	190	230
ØD1	80	100	120
ØD2	80	100	120







Pre presné spojenie a kompatibilitu s existujúcimi žľabmi, zvodovými rúrami a príslušenstvom, je potrebné, aby boli dodržané rozmery podľa údajov STN EN 612.

Menovitý rozmer (mm)		80	100	120
 Hliník farbený Model 80 a 100 	AN	8584074035226	8584074035233	8584074035240
	TM	8584074035462	8584074035479	8584074035486
	SS	8584074035431	8584074035448	8584074035455
	ZH	8584074035493	8584074035509	8584074035516
	BH	8584074035288	8584074035295	8584074035301
	MH	8584074035349	8584074035356	8584074035363
	IC	8584074035318	8584074035325	8584074035332
	OC	8584074035400	8584074035417	8584074035424
	MZ	8584074035370	8584074035387	8584074035394
	B	8584074035257	8584074035264	8584074035271
	ZS	8584074035523	8584074035530	8584074035547
	HM	–	–	–
	OZ	–	–	–
	BHT	–	–	–
 Balenie kartón		 / 8 ks	 / 5 ks	 / 3 ks
 Balenie paleta		 / – ks	 / – ks	 / – ks

Model 120



KJG DESIGN – Hliníkové zachytávače vody so sítom

 3D – náhľad	 Produktový prospekt web
 Technický list o produkte	 Objednávkové číslo
 Montážny list	 Balenie

KVALITA MATERIÁLU A POVRCHOVÁ ÚPRAVA:

- EN AW–1050A H24, S1=0,70mm
- Práškový lak, séria 29, fasádne použitie na báze polyesteru, vysoká odolnosť voči poveternostným vplyvom a veľmi dobré mechanické vlastnosti, stupeň lesku ISO 28/13 – 60°, neplatí pre metalické efekty