

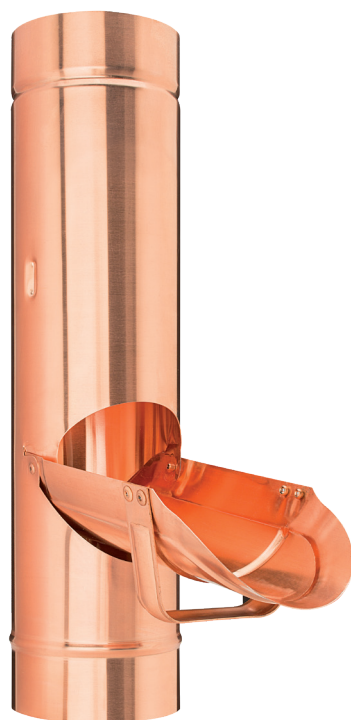

Model 80 a 100



Model 120



Model 80 a 100

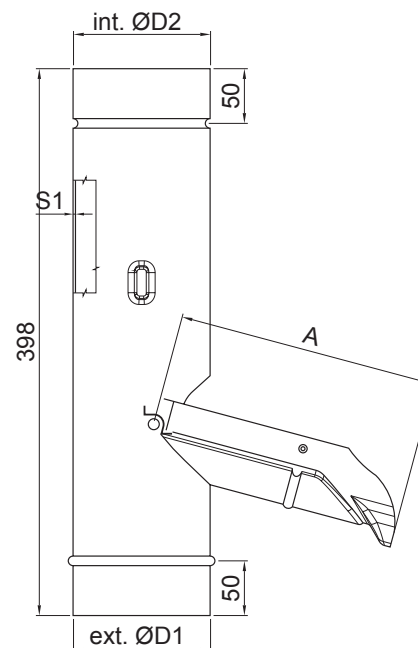



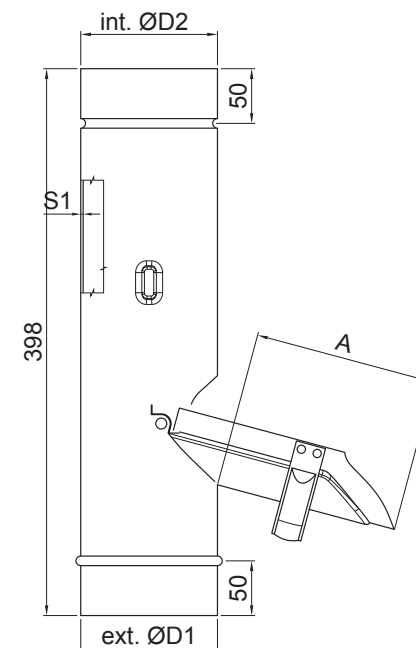





Model 120









Menovité rozmery (mm)	80	100	120
S1	0,55	0,55	0,55
A	150	190	230
ØD1	80	100	120
ØD2	80	100	120

Pre presné spojenie a kompatibilitu s existujúcimi žľabmi, zvodovými rúrami a príslušenstvom, je potrebné, aby boli dodržané rozmery podľa údajov STN EN 612.

Artikel – Objednávkové číslo MZV ✱ PRÉMIUM 80, 100

Menovitý rozmer (mm)	80	100	120
● Med' Cu – DHP EN 1652/1997 R240, S=0,55mm	●	●	●
 Objednávkové číslo	8584074034953	8584074034960	8584074034977
 Balenie kartón	 / 8 ks	 / 5 ks	 / 3 ks
 Balenie paleta	 / 240 ks	 / 150 ks	 / 90 ks

KJG DESIGN – Medené zachytávače vody

 3D – náhľad	 Produktový prospekt web
 Technický list o produkte	 Objednávkové číslo
 Montážny list	 Balenie